

TOSHIBA

Leading Innovation >>>



Installation Manual

Indoor Unit

Model name: _____



1121250199

High-Wall Type

For commercial use

MMK-AP0057HP-E, MMK-AP0057HP-E1

MMK-AP0077HP-E, MMK-AP0077HP-E1

MMK-AP0097HP-E, MMK-AP0097HP-E1

MMK-AP0127HP-E, MMK-AP0127HP-E1

When the E1 model (MMK-AP*HP-E1) is installed,
PMV Kit (RBM-PMV0363E) is necessary

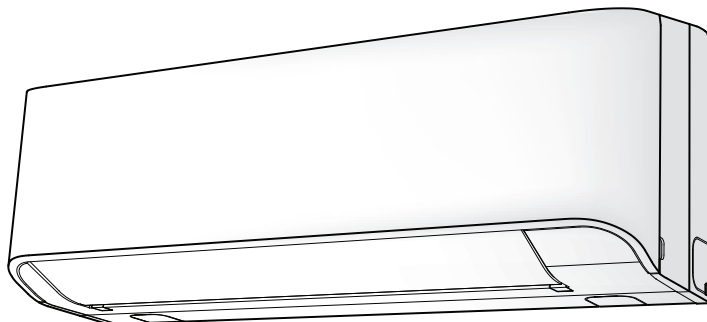

Please read this Installation Manual carefully before installing the Air Conditioner.

- This Manual describes the installation method of the indoor unit.
- For installation of the outdoor unit, follow the Installation Manual attached to the outdoor unit.

ADOPTION OF NEW REFRIGERANT

This Air Conditioner is a new type which adopts a new refrigerant HFC (R410A) instead of the conventional refrigerant R22 in order to prevent destruction of the ozone layer.

Contents

1	PRECAUTIONS FOR SAFETY	5
2	ACCESSORY PARTS	11
3	SELECTION OF INSTALLATION PLACE	12
4	INSTALLATION OF INDOOR UNIT	14
5	CUTTING A HOLE AND MOUNTING INSTALLATION PLATE	15
6	PIPING AND DRAIN HOSE INSTALLATION	16
7	INDOOR UNIT FIXING	19
8	DRAINAGE	19
9	REFRIGERANT PIPING	20
10	ELECTRIC WORK	22
11	APPLICABLE CONTROLS	28
12	TEST RUN	31
13	TROUBLESHOOTING	33

Thank you for purchasing this Toshiba air conditioner.

Please read carefully through these instructions that contain important information which complies with the “Machinery” Directive (Directive 2006 / 42 / EC), and ensure that you understand them.

After completing the installation work, hand over this Installation Manual as well as the Owner’s Manual provided to the user, and ask the user to keep them in a safe place for future reference.

Generic Denomination: Air Conditioner

Definition of Qualified Installer or Qualified Service Person

The air conditioner must be installed, maintained, repaired and removed by a qualified installer or qualified service person. When any of these jobs is to be done, ask a qualified installer or qualified service person to do them for you.

A qualified installer or qualified service person is an agent who has the qualifications and knowledge described in the table below.

Agent	Qualifications and knowledge which the agent must have
Qualified installer	<ul style="list-style-type: none"> • The qualified installer is a person who installs, maintains, relocates and removes the air conditioners made by Toshiba Carrier Corporation. He or she has been trained to install, maintain, relocate and remove the air conditioners made by Toshiba Carrier Corporation or, alternatively, he or she has been instructed in such operations by an individual or individuals who have been trained and is thus thoroughly acquainted with the knowledge related to these operations. • The qualified installer who is allowed to do the electrical work involved in installation, relocation and removal has the qualifications pertaining to this electrical work as stipulated by the local laws and regulations, and he or she is a person who has been trained in matters relating to electrical work on the air conditioners made by Toshiba Carrier Corporation or, alternatively, he or she has been instructed in such matters by an individual or individuals who have been trained and is thus thoroughly acquainted with the knowledge related to this work. • The qualified installer who is allowed to do the refrigerant handling and piping work involved in installation, relocation and removal has the qualifications pertaining to this refrigerant handling and piping work as stipulated by the local laws and regulations, and he or she is a person who has been trained in matters relating to refrigerant handling and piping work on the air conditioners made by Toshiba Carrier Corporation or, alternatively, he or she has been instructed in such matters by an individual or individuals who have been trained and is thus thoroughly acquainted with the knowledge related to this work. • The qualified installer who is allowed to work at heights has been trained in matters relating to working at heights with the air conditioners made by Toshiba Carrier Corporation or, alternatively, he or she has been instructed in such matters by an individual or individuals who have been trained and is thus thoroughly acquainted with the knowledge related to this work.
Qualified service person	<ul style="list-style-type: none"> • The qualified service person is a person who installs, repairs, maintains, relocates and removes the air conditioners made by Toshiba Carrier Corporation. He or she has been trained to install, repair, maintain, relocate and remove the air conditioners made by Toshiba Carrier Corporation or, alternatively, he or she has been instructed in such operations by an individual or individuals who have been trained and is thus thoroughly acquainted with the knowledge related to these operations. • The qualified service person who is allowed to do the electrical work involved in installation, repair, relocation and removal has the qualifications pertaining to this electrical work as stipulated by the local laws and regulations, and he or she is a person who has been trained in matters relating to electrical work on the air conditioners made by Toshiba Carrier Corporation or, alternatively, he or she has been instructed in such matters by an individual or individuals who have been trained and is thus thoroughly acquainted with the knowledge related to this work. • The qualified service person who is allowed to do the refrigerant handling and piping work involved in installation, repair, relocation and removal has the qualifications pertaining to this refrigerant handling and piping work as stipulated by the local laws and regulations, and he or she is a person who has been trained in matters relating to refrigerant handling and piping work on the air conditioners made by Toshiba Carrier Corporation or, alternatively, he or she has been instructed in such matters by an individual or individuals who have been trained and is thus thoroughly acquainted with the knowledge related to this work. • The qualified service person who is allowed to work at heights has been trained in matters relating to working at heights with the air conditioners made by Toshiba Carrier Corporation or, alternatively, he or she has been instructed in such matters by an individual or individuals who have been trained and is thus thoroughly acquainted with the knowledge related to this work.

Definition of Protective Gear





When the air conditioner is to be transported, installed, maintained, repaired or removed, wear protective gloves and 'safety' work clothing.

In addition to such normal protective gear, wear the protective gear described below when undertaking the special work detailed in the table below.

Failure to wear the proper protective gear is dangerous because you will be more susceptible to injury, burns, electric shocks and other injuries.

Work undertaken	Protective gear worn
All types of work	Protective gloves 'Safety' working clothing
Electrical-related work	Gloves to provide protection for electricians and from heat Insulating shoes Clothing to provide protection from electric shock
Work done at heights (50 cm or more)	Helmets for use in industry
Transportation of heavy objects	Shoes with additional protective toe cap
Repair of outdoor unit	Gloves to provide protection for electricians and from heat

■ Warning indications on the air conditioner unit

Warning indication	Description		
 <table border="1" data-bbox="349 294 625 472"> <tr> <td data-bbox="349 294 625 346">WARNING</td> </tr> <tr> <td data-bbox="349 346 625 472"> ELECTRICAL SHOCK HAZARD Disconnect all remote electric power supplies before servicing. </td> </tr> </table>	WARNING	ELECTRICAL SHOCK HAZARD Disconnect all remote electric power supplies before servicing.	WARNING ELECTRICAL SHOCK HAZARD Disconnect all remote electric power supplies before servicing.
WARNING			
ELECTRICAL SHOCK HAZARD Disconnect all remote electric power supplies before servicing.			
 <table border="1" data-bbox="349 535 625 714"> <tr> <td data-bbox="349 535 625 588">WARNING</td> </tr> <tr> <td data-bbox="349 588 625 714"> Moving parts. Do not operate unit with grille removed. Stop the unit before the servicing. </td> </tr> </table>	WARNING	Moving parts. Do not operate unit with grille removed. Stop the unit before the servicing.	WARNING Moving parts. Do not operate unit with grille removed. Stop the unit before the servicing.
WARNING			
Moving parts. Do not operate unit with grille removed. Stop the unit before the servicing.			
 <table border="1" data-bbox="349 777 625 955"> <tr> <td data-bbox="349 777 625 829">CAUTION</td> </tr> <tr> <td data-bbox="349 829 625 955"> High temperature parts. You might get burned when removing this panel. </td> </tr> </table>	CAUTION	High temperature parts. You might get burned when removing this panel.	CAUTION High temperature parts. You might get burned when removing this panel.
CAUTION			
High temperature parts. You might get burned when removing this panel.			
 <table border="1" data-bbox="349 1018 625 1197"> <tr> <td data-bbox="349 1018 625 1071">CAUTION</td> </tr> <tr> <td data-bbox="349 1071 625 1197"> Do not touch the aluminum fins of the unit. Doing so may result in injury. </td> </tr> </table>	CAUTION	Do not touch the aluminum fins of the unit. Doing so may result in injury.	CAUTION Do not touch the aluminium fins of the unit. Doing so may result in injury.
CAUTION			
Do not touch the aluminum fins of the unit. Doing so may result in injury.			
 <table border="1" data-bbox="349 1260 625 1438"> <tr> <td data-bbox="349 1260 625 1312">CAUTION</td> </tr> <tr> <td data-bbox="349 1312 625 1438"> BURST HAZARD Open the service valves before the operation, otherwise there might be the burst. </td> </tr> </table>	CAUTION	BURST HAZARD Open the service valves before the operation, otherwise there might be the burst.	CAUTION BURST HAZARD Open the service valves before the operation, otherwise there might be the burst.
CAUTION			
BURST HAZARD Open the service valves before the operation, otherwise there might be the burst.			

1 PRECAUTIONS FOR SAFETY

- Ensure that all Local, National and International regulations are satisfied.
- Read this “PRECAUTIONS FOR SAFETY” carefully before Installation.
- The precautions described below include the important items regarding safety.
Observe them without fail.
- After the installation work, perform a trial operation (test run) to check for any problem.
Follow the Owner’s Manual to explain how to use and maintain the unit to the customer.
- Turn off the main power supply switch (or breaker) before the unit maintenance.
- Ask the customer to keep the Installation Manual together with the Owner’s Manual.

The manufacturer shall not assume any liability for the damage caused by not observing the description of this manual.

WARNING

General

- Before starting to install the air conditioner, read through the Installation Manual carefully, and follow its instructions to install the air conditioner.
- Only a qualified installer(*1) or qualified service person(*1) is allowed to do installation work. Inappropriate installation may result in water leakage, electric shock or fire.
- Do not use any refrigerant different from the one specified for complement or replacement. Otherwise, abnormally high pressure may be generated in the refrigeration cycle, which may result in a failure or explosion of the product or an injury to your body.
- Before opening the front panel of the indoor unit or service panel of the outdoor unit, set the circuit breaker to the OFF position. Failure to set the circuit breaker to the OFF position may result in electric shocks through contact with the interior parts. Only a qualified installer(*1) or qualified service person(*1) is allowed to remove the front panel of the indoor unit or service panel of the outdoor unit and do the work required.
- Before carrying out the installation, maintenance, repair or removal work, be sure to set the circuit breaker to the OFF position. Otherwise, electric shocks may result.
- Place a “Work in progress” sign near the circuit breaker while the installation, maintenance, repair or removal work is being carried out. There is a danger of electric shocks if the circuit breaker is set to ON by mistake.
- Only a qualified installer(*1) or qualified service person(*1) is allowed to undertake work at heights using a stand of 50 cm or more or to remove the front panel of the indoor unit to undertake work.
- Wear protective gloves and safety work clothing during installation, servicing and removal.

- Do not touch the aluminium fin of the unit. You may injure yourself if you do so. If the fin must be touched for some reason, first put on protective gloves and safety work clothing, and then proceed.
- Do not climb onto or place objects on top of the outdoor unit. You may fall or the objects may fall off of the outdoor unit and result in injury.
- When work is performed at heights, use a ladder which complies with the ISO 14122 standard, and follow the procedure in the ladder's instructions. Also wear a helmet for use in industry as protective gear to undertake the work.
- Before cleaning the filter or other parts of the outdoor unit, set the circuit breaker to OFF without fail, and place a "Work in progress" sign near the circuit breaker before proceeding with the work.
- Before working at heights, put a sign in place so that no-one will approach the work location, before proceeding with the work. Parts and other objects may fall from above, possibly injuring a person below. While carrying out the work, wear a helmet for protection from falling objects.
- The refrigerant used by this air conditioner is the R410A.
- The air conditioner must be transported in stable condition. If any part of the product is broken, contact the dealer.
- When the air conditioner must be transported by hand, carry it by two or more people.
- Do not move or repair any unit by yourself. There is high voltage inside the unit. You may get electric shock while removing the cover and main unit.
- This appliance is intended to be used by expert or trained users in shops, in light industry, or for commercial use by lay persons.

Selection of installation location

- When the air conditioner is installed in a small room, provide appropriate measures to ensure that the concentration of refrigerant leakage occur in the room does not exceed the critical level.
- Do not install the air conditioner in a location that may be subject to a risk of exposure to a combustible gas. If a combustible gas leaks and becomes concentrated around the unit, a fire may occur.
- To transport the air conditioner, wear shoes with additional protective toe caps.
- To transport the air conditioner, do not take hold of the bands around the packing carton. You may injure yourself if the bands should break.
- Do not place any combustion appliance in a place where it is directly exposed to the wind of air conditioner, otherwise it may cause imperfect combustion.
- Do not install in a location where flammable gas leaks are possible. If the gas leak and accumulate around the unit, it may ignite and cause a fire.
- Install the indoor unit at least 2.5 m above the floor level since otherwise the users may injure themselves or receive electric shocks if they poke their fingers or other objects into the indoor unit while the air conditioner is running.

Installation

- Install the air conditioner securely in a location where the base can sustain the weight adequately. If the strength is not enough, the unit may fall down resulting in injury.
- Follow the instructions in the Installation Manual to install the air conditioner. Failure to follow these instructions may cause the product to fall down or topple over or give rise to noise, vibration, water leakage or other trouble.
- Carry out the specified installation work to guard against the possibility of high winds and earthquake. If the air conditioner is not installed appropriately, a unit may topple over or fall down, causing an accident.
- If refrigerant gas has leaked during the installation work, ventilate the room immediately. If the leaked refrigerant gas comes in contact with fire, noxious gas may generate.
- Use forklift to carry in the air conditioner units and use winch or hoist at installation of them.

Refrigerant piping

- Install the refrigerant pipe securely during the installation work before operating the air conditioner. If the compressor is operated with the valve open and without refrigerant pipe, the compressor sucks air and the refrigeration cycle is over pressurized, which may cause an injury.
- Tighten the flare nut with a torque wrench in the specified manner. Excessive tightening of the flare nut may cause a crack in the flare nut after a long period, which may result in refrigerant leakage.
- After the installation work, confirm that refrigerant gas does not leak. If refrigerant gas leaks into the room and flows near a fire source, such as a cooking range, noxious gas may be generated.
- When the air conditioner has been installed or relocated, follow the instructions in the Installation Manual and purge the air completely so that no gases other than the refrigerant will be mixed in the refrigerating cycle. Failure to purge the air completely may cause the air conditioner to malfunction.
- Nitrogen gas must be used for the airtight test.
- The charge hose must be connected in such a way that it is not slack.

Electrical wiring

- Only a qualified installer(*1) or qualified service person(*1) is allowed to carry out the electrical work of the air conditioner. Under no circumstances must this work be done by an unqualified individual since failure to carry out the work properly may result in electric shocks and/or electrical leaks.
- To connect the electrical wires, repair the electrical parts or undertake other electrical jobs, wear gloves to provide protection for electricians and from heat, insulating shoes and clothing to provide protection from electric shocks. Failure to wear this protective gear may result in electric shocks.
- Use wiring that meets the specifications in the Installation Manual and the stipulations in the local regulations and laws. Use of wiring which does not meet the specifications may give rise to electric shocks, electrical leakage, smoking and/or a fire.

- Connect earth wire. (grounding work)
Incomplete grounding causes an electric shock.
- Do not connect earth wires to gas pipes, water pipes, and lightning conductor or telephone earth wires.
- After completing the repair or relocation work, check that the earth wires are connected properly.
- Install a circuit breaker that meets the specifications in the installation manual and the stipulations in the local regulations and laws.
- Install the circuit breaker where it can be easily accessed by the agent.
- When installing the circuit breaker outdoors, install one which is designed to be used outdoors.
- Under no circumstances the power wire must not be extended. Connection trouble in the places where the wire is extended may give rise to smoking and/or a fire.
- Electrical wiring work shall be conducted according to law and regulation in the community and installation manual. Failure to do so may result in electrocution or short circuit.

Test run

- Before operating the air conditioner after having completed the work, check that the electrical control box cover of the indoor unit and service panel of the outdoor unit are closed, and set the circuit breaker to the ON position. You may receive an electric shock if the power is turned on without first conducting these checks.
- If there is any kind of trouble (such as an error display has appeared, smell of burning, abnormal sounds, the air conditioner fails to cool or heat or water is leaking) has occurred in the air conditioner, do not touch the air conditioner yourself but set the circuit breaker to the OFF position, and contact a qualified service person.
Take steps to ensure that the power will not be turned on (by marking “out of service” near the circuit breaker, for instance) until qualified service person(*1) arrives. Continuing to use the air conditioner in the trouble status may cause mechanical problems to escalate or result in electric shocks or other trouble.
- After the work has finished, use an insulation tester set (500 V Megger) to check the resistance is 1 MΩ or more between the charge section and the non-charge metal section (earth section). If the resistance value is low, a disaster such as a leak or electric shock is caused at user’s side.
- Upon completion of the installation work, check for refrigerant leaks and check the insulation resistance and water drainage. Then conduct a test run to check that the air conditioner is operating properly.

Explanations given to user

- Upon completion of the installation work, tell the user where the circuit breaker is located. If the user does not know where the circuit breaker is, he or she will not be able to turn it off in the event that trouble has occurred in the air conditioner.
- If the fan grille is damaged, do not approach the outdoor unit but set the circuit breaker to the OFF position, and contact a qualified service person(*1) to have the repairs done. Do not set the circuit breaker to the ON position until the repairs are completed.
- After the installation work, follow the Owner's Manual to explain to the customer how to use and maintain the unit.

Relocation

- Only a qualified installer(*1) or qualified service person(*1) is allowed to relocate the air conditioner. It is dangerous for the air conditioner to be relocated by an unqualified individual since a fire, electric shocks, injury, water leakage, noise and/or vibration may result.
 - While carrying out the pump-down work shut down the compressor before disconnecting the refrigerant pipe. Disconnecting the refrigerant pipe with the service valve left open and the compressor still operating will cause air or other gas to be sucked in, raising the pressure inside the refrigeration cycle to an abnormally high level, and possibly resulting in rupture, injury or other trouble.
-

 **CAUTION**

New refrigerant air conditioner installation

- **This air conditioner adopts the new HFC refrigerant (R410A) which does not destroy ozone layer.**
- The characteristics of R410A refrigerant are; easy to absorb water, oxidizing membrane or oil, and its pressure is approx. 1.6 times higher than that of refrigerant R22. Accompanied with the new refrigerant, refrigerating oil has also been changed. Therefore, during installation work, be sure that water, dust, former refrigerant, or refrigerating oil does not enter the refrigerating cycle.
- To prevent charging an incorrect refrigerant and refrigerating oil, the sizes of connecting sections of charging port of the main unit and installation tools are changed from those for the conventional refrigerant.
- Accordingly the exclusive tools are required for the new refrigerant (R410A).
- For connecting pipes, use new and clean piping designed for R410A, and please care so that water or dust does not enter.

To disconnect the appliance from main power supply.







- This appliance must be connected to the main power supply by means of a switch with a contact separation of at least 3 mm.

The installation fuse (all types can be used) must be used for the power supply line of this conditioner.

Install the indoor unit at least 2.5 m above the floor level since otherwise the users may injure themselves or receive electric shocks if they poke their fingers or other objects into the indoor unit while the air conditioner is running.

(*1) Refer to the “Definition of Qualified Installer or Qualified Service Person”.

2 ACCESSORY PARTS

Part name	Q'ty	Shape	Usage
Installation Manual	1	This manual	(Hand over to customers) (For other languages that do not appear in this installation Manual, please refer to the enclosed CD-R.)
Owner's Manual	1		(Hand over to customers) (For other languages that do not appear in this installation Manual, please refer to the enclosed CD-R.)
CD-ROM	1	-	Owner's Manual and Installation Manual.
Installation plate	1		
Wireless remote controller	1		
Battery	2		
Remote controller holder	1		
Mounting screw $\varnothing 4 \times 25 \ell$	6		
Pan head wood screw $\varnothing 3.1 \times 16 \ell$	2		

3 SELECTION OF INSTALLATION PLACE

WARNING

- **Install the air conditioner at enough strong place to withstand the weight of the unit.**
If the strength is not enough, the unit may fall down resulting in injury.

CAUTION

- **Do not install the air conditioner in a location subject to a risk of exposure to a combustible gas.**
If a combustible gas leaks and stays around the unit, a fire may occur.

Upon approval of the customer, install the air conditioner in a place that satisfies the following conditions.

- Place where the unit can be installed horizontally.
- Place where a sufficient servicing space can be ensured for safety maintenance and check.
- Place where drained water will not cause any problem.

Avoid installing in the following places.

Select a location for the indoor unit where the cool or warm air will circulate evenly.

Avoid installation in the following kinds of locations.

- Saline area (coastal area).
- Locations with acidic or alkaline atmospheres (such as areas with hot springs, factories where chemicals or pharmaceuticals are made and places where the exhaust air from combustion appliances will be sucked into the unit).
Doing so may cause the heat exchanger (its aluminum fins and copper pipes) and other parts to become corroded.
- Locations with atmospheres with mist of cutting oil or other types of machine oil.
Doing so may cause the heat exchanger to become corroded, mists caused by the blockage of the heat exchanger to be generated, the plastic parts to be damaged, the heat insulators to peel off, and other such problems to result.
- Places where iron or other metal dust is present. If iron or other metal dust adheres to or collects on the interior of the air conditioner, it may spontaneously combust and start a fire.
- Locations where vapors from food oils are formed (such as kitchens where food oils are used).
Blocked filters may cause the air conditioner's performance to deteriorate, condensation to form, the plastic parts to be damaged, and other such problems to result.
- Locations near obstructions such as ventilation openings or lighting fixtures where the flow of the blown air will be disrupted (a disruption of the air flow may cause the air conditioner's performance to deteriorate or the unit to shut down).
- Locations where an in-house power generator is used for the power supply.
The power line frequency and voltage may fluctuate, and the air conditioner may not work properly as a result.
- On truck cranes, ships or other moving conveyances.
- The air conditioner must not be used for special applications (such as for storing food, plants, precision instruments or art works).
(The quality of the items stored may be degraded.)
- Locations where high frequencies are generated (by inverter equipment, in-house power generators, medical equipment or communication equipment).
(Malfunctioning or control trouble in the air conditioner or noise may adversely affect the equipment's operation.)
- Locations where there is anything under the unit installed that would be compromised by wetness.
(If the drain has become blocked or when the humidity is over 80 %, condensation from the indoor unit will drip, possibly causing damage to anything underneath.)
- In the case of the wireless type of system, rooms with the inverter type of fluorescent lighting or locations exposed to direct sunlight.
(The signals from the wireless remote controller may not be sensed.)
- Locations where organic solvents are being used.
- The air conditioner cannot be used for liqueed carbonic acid cooling or in chemical plants.
- Location near doors or windows where the air conditioner may come into contact with high-temperature, high-humidity outdoor air.
(Condensation may occur as a result.)
- Locations where special sprays are used frequently.

■ Installation diagram of Indoor and outdoor units

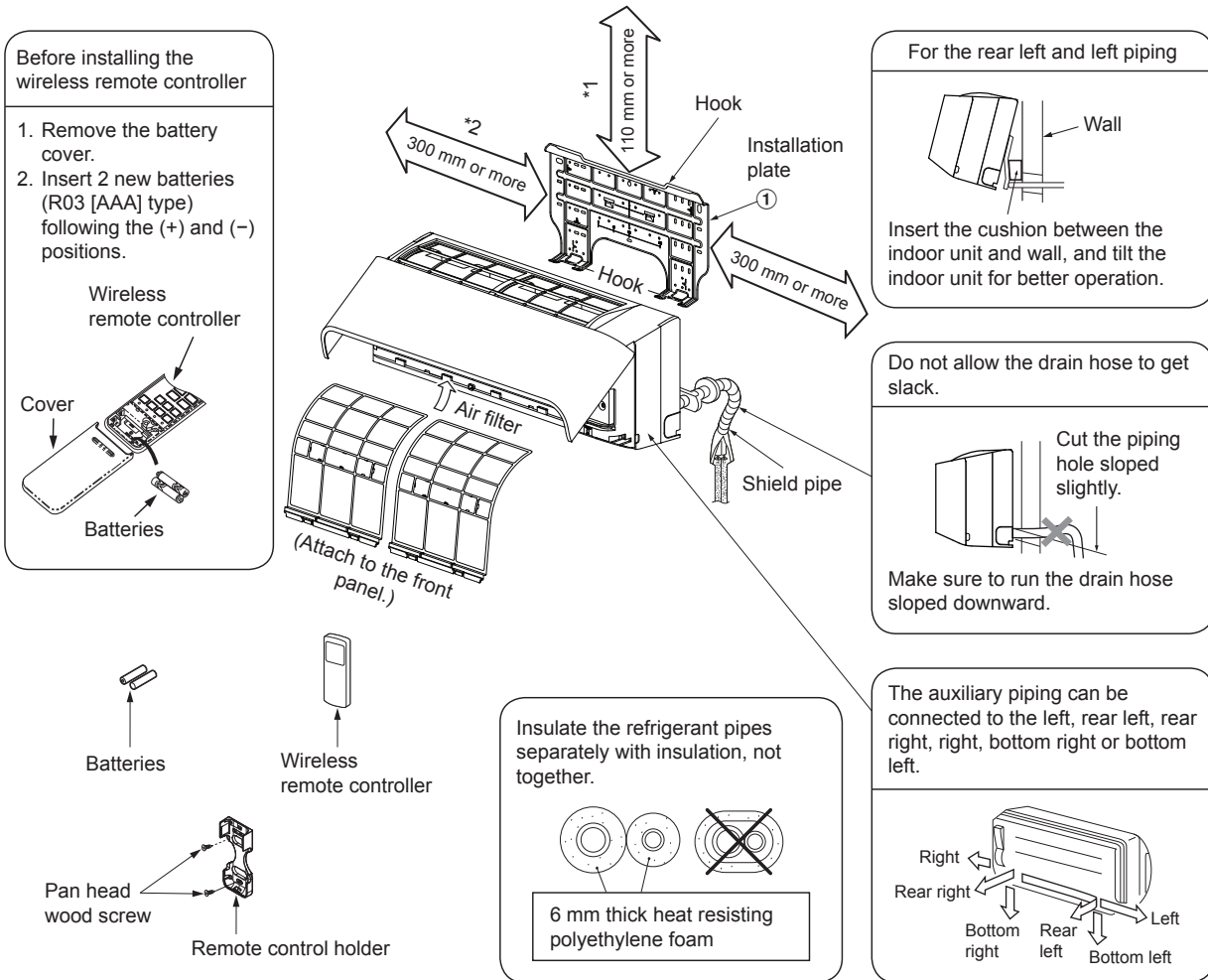

■ Installation space

The indoor unit shall be installed so that its top surface comes at a height of 2.5m or more. Also it must be avoided to put anything on top of the indoor unit.

*1 Reserve space required to install the indoor unit and for service work.

Keep 110mm or more for clearance between top plate of the indoor unit and the ceiling surface.

*2 Provide a space as shown for service clearance for the cross flow fan.

■ Installation place

- A place which provides the spaces around the indoor unit as shown in the above diagram.
- A place where there is no obstacle near the air inlet and outlet.
- A place that allows easy installation of the piping to the outdoor unit.
- A place which allows the front panel to be opened.

⚠ CAUTION

- Direct sunlight to the indoor unit's wireless receiver should be avoided.
- The microprocessor in the indoor unit should not be too close to RF noise sources. (For details, see the owner's manual.)

■ Wireless remote controller

- A place where there are no obstacles such as a curtain that may block the signal from the indoor unit.
- Do not install the remote controller in a place exposed to direct sunlight or close to a heating source, such as a stove.
- Keep the remote controller at least 1m apart from the nearest TV set or stereo equipment. (This is necessary to prevent image disturb-bounces or noise interference.)
- The location of the remote controller should be determined as shown below.

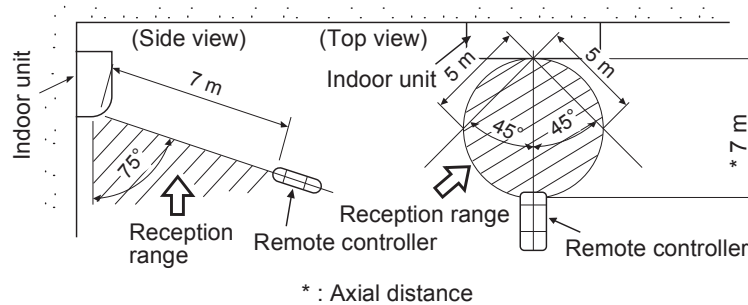

4 INSTALLATION OF INDOOR UNIT

⚠ WARNING

Install the air conditioner certainly to sufficiently withstand the weight.
If the strength is insufficient, the unit may fall down resulting in human injury.
Perform a specified installation work to guard against strong wind or earthquake.
An incomplete installation can cause accidents by the units falling and dropping.

REQUIREMENT

Strictly comply with the following rules to prevent damage of the indoor units and human injury.

- Do not put a heavy article on the indoor unit. (Even units are packaged)
- Carry in the indoor unit as it is packaged if possible. If carrying in the indoor unit unpacked by necessity, be sure to use buffering cloth, etc. to not damage the unit.
- To move the indoor unit, do not apply force to the refrigerant pipe, drain pan, foamed parts, or resin parts, etc.
- Carry the package by two or more persons, and do not bundle it with plastic band at positions other than specified.

Be careful to the following items when installing the unit.

- Considering air discharge direction, select an installation place where discharge air can circulate evenly in a room. Avoid to install the unit at place with "NO GOOD" mark in the right figure.

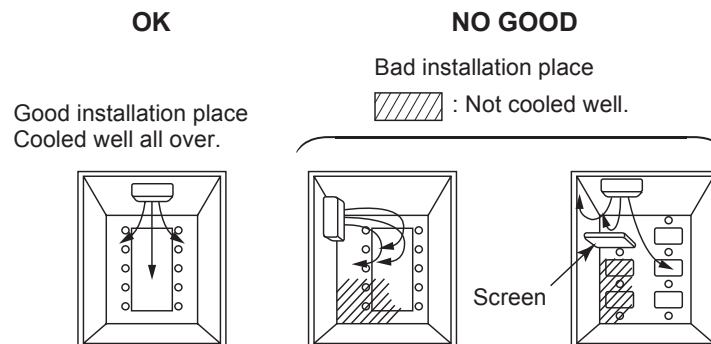

5 CUTTING A HOLE AND MOUNTING INSTALLATION PLATE

■ Cutting a hole

In case of installing the refrigerant pipes from the rear:

1. Decide the hole position for piping at 180mm from the arrow mark (⇒) on the installation plate and drill a hole at a slight downward slant toward outdoor side.

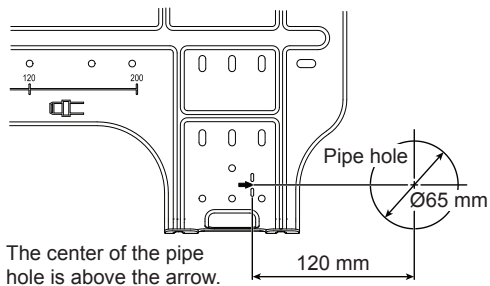

NOTE

- When drilling a wall that contains a metal lath, wire lath or metal plate, be sure to use a pipe hole brim ring sold separately.

■ Mounting the installation plate

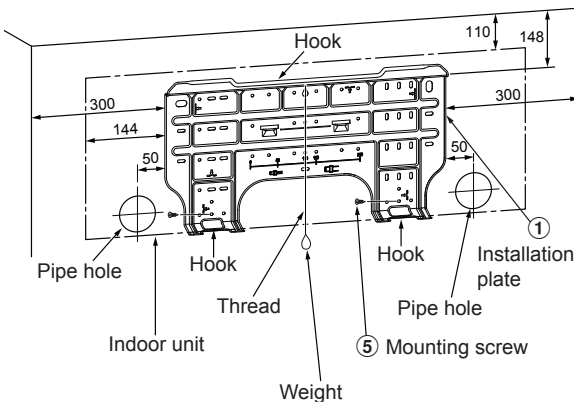

■ When the installation plate is directly mounted on the wall

1. Securely fit the installation plate onto the wall by screwing it in the upper and lower parts to hook up the indoor unit.
2. To mount the installation plate on a concrete wall with anchor bolts, utilize the anchor bolt holes as illustrated in the above figure.
3. Install the installation plate horizontally in the wall.

⚠ CAUTION

When installing the installation plate with a mounting screw, do not use the anchor bolt hole. Otherwise the unit may fall down and result in personal injury and property damage.

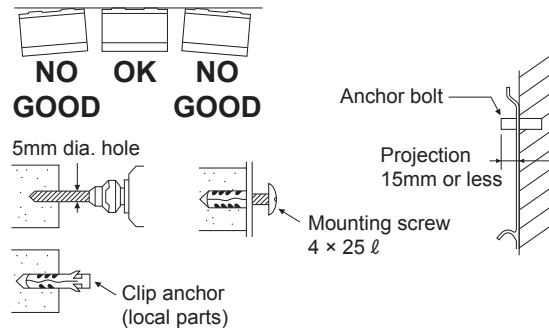

⚠ CAUTION

Failure to firmly install the unit may result in personal injury and property damage if the unit falls.

- In case of block, brick, concrete or similar type walls, make 5mm dia. holes in the wall.
- Insert clip anchors for appropriate mounting screws.

NOTE

- Secure four corners and lower parts of the installation plate with 6 mounting screws to install it.

6 PIPING AND DRAIN HOSE INSTALLATION

■ Piping and drain hose forming

* Apply heat-insulation for both refrigerant pipe and drain hose surely so that no dew generates inside of the equipment. (Use polyethylene foam for insulating material.)

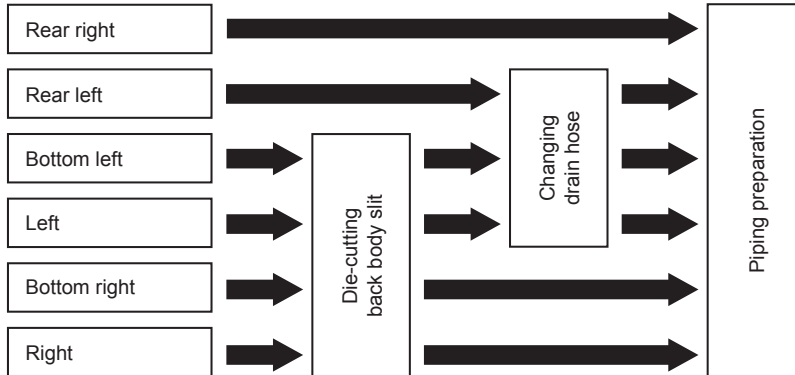

1. Die-cutting back body slit

Cut out the slit on the left or right side of the back body for the left or right connection and the slit on the bottom left or right side of the back body for the bottom left or right connection with a pair of nippers.

2. Changing drain hose

For leftward connection, bottom-leftward connection and rear leftward connection's piping, it is necessary to change the drain hose and drain cap.

Without changing the drain hose position, the indoor unit will not fit to the wall.

How to remove the drain hose

- The drain hose can be removed by removing the screw securing the drain hose and then pulling out the drain hose.
- When removing the drain hose, be careful of any sharp edges of steel plate. The edges can injuries.
- To install the drain hose, insert the drain hose firmly until the connection part contacts with heat insulator, and then secure it with original screw.

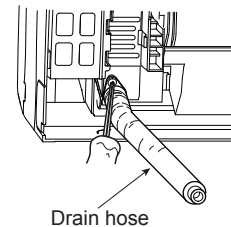

How to remove the drains cap

Clip the drain cap by needle-nose pliers and pull out.

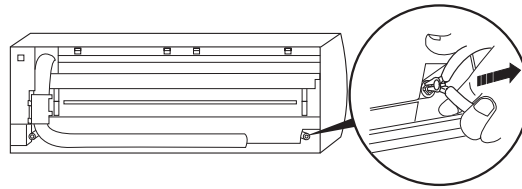

How to fix the drains cap

1) Insert hexagonal wrench (dia. 4mm) in a centre head.

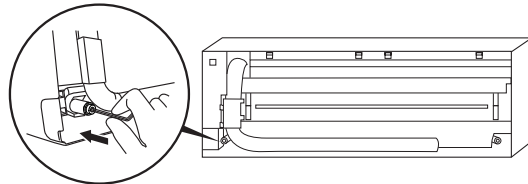

2) Firmly insert drains cap.

Do not apply lubricating oil (refrigerant machine oil) when inserting the drain cap. Application causes deterioration and drain leakage from the plug.

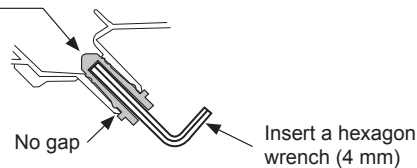

⚠ CAUTION

Firmly insert the drain hose and drain cap; otherwise, water may leak.

How to remove the drain hose

- 1) Remove the front panel.
- 2) Remove the screws of drain hose.
- 3) Pull out the drain hose.

▼ In case of right or left piping

- After scribing slits of the front panel with a knife or a marking-off pin, cut them with a pair of nippers or an equivalent tool.

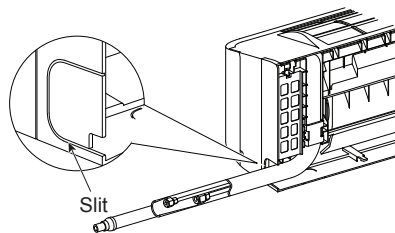

How to fix the drain hose

- 1) Put the drain hose.
- 2) Screw the drain hose to the indoor unit.
- 3) Install the front panel.

▼ In case of bottom right or bottom left piping

- After scribing slits of the front panel with a knife or a marking-off pin, cut them with a pair of nippers or an equivalent tool.

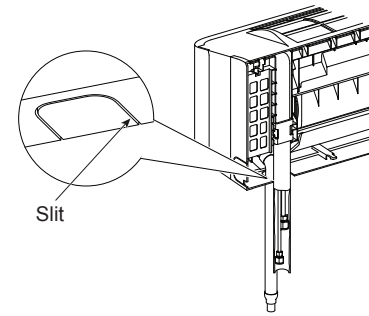

▼ Left-hand connection with piping

Bend the connecting pipe so that it is laid within 43mm above the wall surface. If the connecting pipe is laid exceeding 43mm above the wall surface, the indoor unit may unstably be set on the wall. When bending the connecting pipe, make sure to use a spring bender so as not to crush the pipe.

Bend the connecting pipe within a radius of 30 mm.

To connect the pipe after installation of the unit (figure)

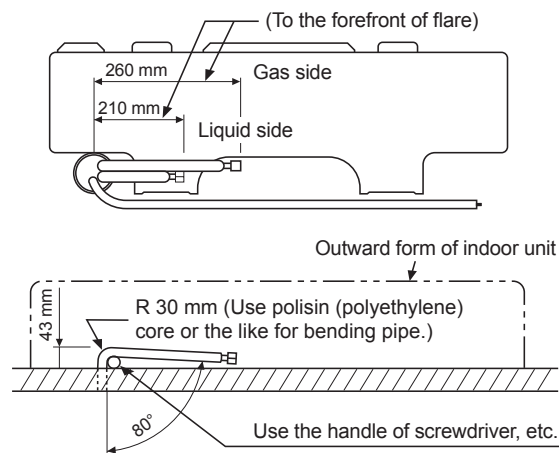

NOTE

If the pipe is bent incorrectly, the indoor unit may unstably be set on the wall. After passing the connecting pipe through the pipe hole, connect the connecting pipe to the auxiliary pipes and wrap the facing tape around them.

! CAUTION

- Bind the auxiliary pipes (two) and power supply wiring and control wiring with facing tape tightly. In case of leftward piping and rear leftward piping, bind the auxiliary pipes (two) only with facing tape.

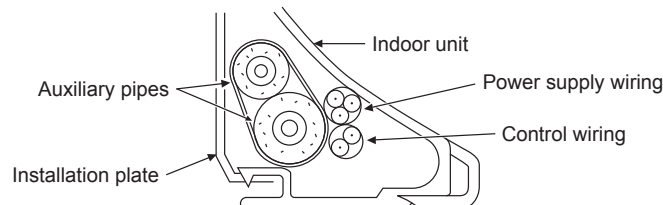

- Carefully arrange pipes so that any pipe does not stick out of the rear plate of the indoor unit.
- Carefully connect the auxiliary pipes and connecting pipes to one another and cut off the insulating tape wound on the connecting pipe to avoid double-taping at the joint; moreover, seal the joint with the vinyl tape, etc.
- Since dew results in a machine trouble, make sure to insulate both the connecting pipes. (Use polyethylene foam as insulating material.)
- When bending a pipe, carefully do it, not to crush it.

7 INDOOR UNIT FIXING

1. Pass the pipe through the hole in the wall, and hook the indoor unit on the installation plate at the upper hooks.
2. Swing the indoor unit to right and left to confirm that it is firmly hooked up on the installation plate.
3. While pressing the indoor unit onto the wall, hook it at the lower part on the installation plate. Pull the indoor unit toward you to confirm that it is firmly hooked up on the installation plate.

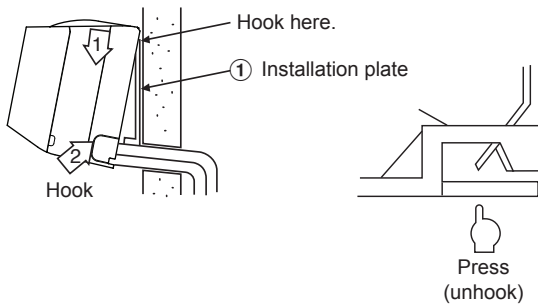

- For detaching the indoor unit from the installation plate, pull the indoor unit toward you while pushing its bottom up at the specified parts.

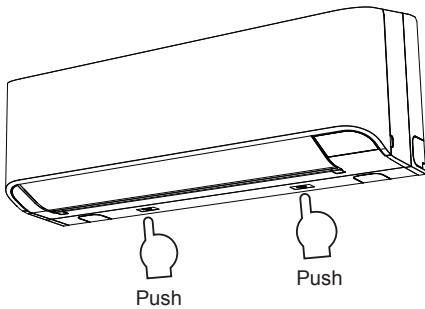

8 DRAINAGE

1. Run the drain hose sloped downwards.

NOTE

- Hole should be made at a slight downward slant on the outdoor side.
2. Put water in the drain pan and make sure that the water is drained out of doors.
 3. When connecting extension drain hose, insulate the connecting part of extension drain hose with shield pipe.

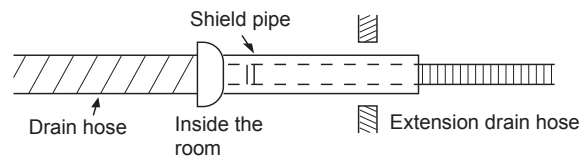
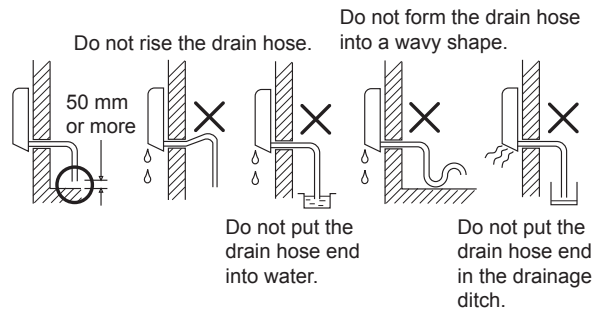

⚠ CAUTION

Arrange the drain pipe for proper drainage from the unit.
Improper drainage can result in dew-dropping.

This air conditioner has the structure designed to drain water collected from dew, which forms on the back of the indoor unit, to the drain pan. Therefore, do not store the power cord and other parts at a height above the drain guide.

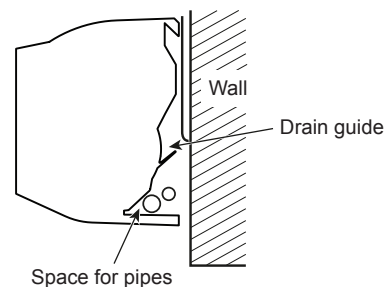

9 REFRIGERANT PIPING

■ Refrigerant Piping

1. Use copper pipe with 0.8mm or more thickness. (In case pipe size is dia. 15.9, with 1.0mm or more.)
2. Flare nut and flare works are also different from those of the conventional refrigerant. Take out the flare nut attached to the main unit of the air conditioner, and use it.

REQUIREMENT

When the refrigerant pipe is long, provide support brackets at intervals of 2.5 to 3m to clamp the refrigerant pipe. Otherwise, abnormal sound may be generated.

CAUTION

IMPORTANT 4 POINTS FOR PIPING WORK

1. Remove dust and moisture from the inside of the connecting pipes.
2. Tight connection (between pipes and unit)
3. Evacuate the air in the connecting pipes using VACUUM PUMP.
4. Check the gas leakage. (Connected points)

■ Pipe size

(dia.: mm)

MMK-	AP005 to AP012 type
Gas side	9.5
Liquid side	6.4

■ Permissible Piping Length and Height Difference

They vary according to the outdoor unit. For details, refer to the Installation Manual attached to the outdoor unit.

Flaring

- Cut the pipe with a pipe cutter. Remove burrs completely. Remaining burrs may cause gas leakage.
- Insert a flare nut into the pipe, and flare the pipe. As the flaring sizes of R410A differ from those of refrigerant R22, the flare tools newly manufactured for R410A are recommended. However, the conventional tools can be used by adjusting projection margin of the copper pipe.

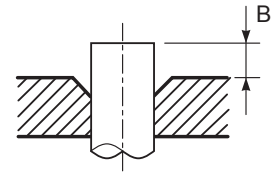

▼ Projection margin in flaring: B (Unit: mm) Rigid (Clutch type)

Outer dia. of copper pipe	R410A tool used	Conventional tool used
	R410A	R410A
6.4, 9.5	0 to 0.5	1.0 to 1.5
12.7, 15.9		

▼ Flaring dia. meter size: A (Unit: mm)

Outer dia. of copper pipe	A ⁺⁰ _{-0.4}
	R410A
6.4	9.1
9.5	13.2
12.7	16.6
15.9	19.7

- * In case of flaring for R410A with the conventional flare tool, pull it out approx. 0.5 mm more than that for R22 to adjust to the specified flare size. The copper pipe gauge is useful for adjusting projection margin size.

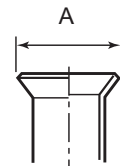

Tightening connection

CAUTION

- Do not apply excessive torque. Otherwise, the nut may crack depending on the conditions.

(Unit: N•m)

Outer dia. of copper pipe	Tightening torque
6.4 mm (dia.)	14 to 18 (1.4 to 1.8 kgf•m)
9.5 mm (dia.)	33 to 42 (3.3 to 4.2 kgf•m)
12.7 mm (dia.)	50 to 62 (5.0 to 6.2 kgf•m)
15.9 mm (dia.)	68 to 82 (6.8 to 8.2 kgf•m)

▼ Tightening torque of flare pipe connections

Pressure of R410A is higher than that of R22. (Approx. 1.6 times) Therefore, using a torque wrench, tighten the flare pipe connecting sections which connect the indoor and outdoor units of the specified tightening torque.

Incorrect connections may cause not only a gas leak, but also a trouble of the refrigeration cycle. Align the centres of the connecting pipes and tighten the flare nut as far as possible with your fingers. Then tighten the nut with a spanner and torque wrench as shown in the figure.

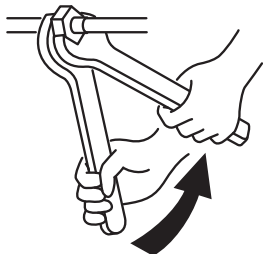

Work using double spanner

REQUIREMENT

Tightening with an excessive torque may crack the nut depending on installation conditions. Tighten the nut within the specified tightening torque.

Piping with outdoor unit

- Shape of valve differs according to the outdoor unit. For details of installation, refer to the Installation Manual of the outdoor unit.

Heat insulation

Heat insulation for the pipes should be done separately for the liquid side and gas side. Because both of the liquid and gas side pipes become a low temperature during cooling operation, sufficient heat insulation should be done to prevent condensation.

- Heat insulator with a heat resistance of 120°C or more must be used for the gas side pipe.

■ Airtight test/Air purge, etc.

For airtight test, air purge, addition of refrigerant, and gas leak check, follow the Installation Manual attached to the outdoor unit.

■ Open fully valves of the outdoor unit

■ Gas leak check

Check with a leak detector or soap water whether gas leaks or not, from the pipe connecting section or cap of the valve.

REQUIREMENT

Use a leak detector manufactured exclusively HFC refrigerant (R410A, R134a, etc.).

10 ELECTRIC WORK

WARNING

1. **Using the specified wires, ensure to connect the wires, and fix wires securely so that the external tension to the wires do not affect the connecting part of the terminals.**
Incomplete connection or fixation may cause a fire, etc.
2. **Be sure to connect earth wire. (grounding work)**
Incomplete grounding cause an electric shock. Do not connect ground wires to gas pipes, water pipes, lightning rods or ground wires for telephone wires.
3. **Appliance shall be installed in accordance with national wiring regulations.**
Capacity shortage of power circuit or incomplete installation may cause an electric shock or a fire.

- Run the refrigerant piping line and control wiring line in the same line.
- Do not turn on the power of the indoor unit until vacuuming of the refrigerant pipes completes.

CAUTION

- If incorrect/incomplete wiring is carried out, it will cause an electrical fire or smoke.
- Be sure to install an earth leakage breaker that is not tripped by shock waves.
If an earth leakage breaker is not installed, an electric shock may be caused.
- Be sure to use the cord clamps attached to the product.
- Do not damage or scratch the conductive core and inner insulator of power and inter-connecting wires when peeling them.
- Use the power cord and Inter-connecting wire of specified thickness, type, and protective devices required.
- Never connect 220–240V power to the terminal blocks (U₁, U₂, A, B, etc.) for control wiring.
(Otherwise, the system will fail.)

REQUIREMENT

- For power supply wiring, strictly conform to the Local Regulation in each country.
- For wiring of power supply of the outdoor units, follow the Installation Manual of each outdoor unit.
- Perform the electric wiring so that it does not come to contact with the high-temperature part of the pipe.
The coating may melt resulting in an accident.
- After connecting wires to the terminal blocks, provide a trap and fix wires with the cord clamp.

■ Power supply wire and communication wires specifications

Power supply wire and communication wires are procured locally.

For the power supply specifications, follow the table below. Power supply wiring and communication wiring are to be procured locally.

For specifications of the power capacity of the outdoor unit and the power supply wires, refer to the Installation Manual supplied with the outdoor unit.

Indoor unit power supply

- Prepare an exclusive power supply for the indoor unit independently of the outdoor unit.
- Arrange the power supplies to the indoor and outdoor units, so that a common earth leakage breaker and main switch can be used.
- Power supply wire specification: Cable 3-core 2.5mm², **in conformity with Design H07 RN-F or 60245 IEC 57.**

▼ Power supply

Power supply	220–240V ~ 50Hz 220V ~ 60Hz	
Power supply switch/Earth leakage breaker or power supply wiring/fuse rating for indoor units should be selected by the accumulated total current values of the indoor units.		
Power supply wiring	Below 50m	2.5 mm ²

Control wiring, Central controller wiring

- Use a 2 core non polarity wire.
- To prevent any possible noise issues, use a shielded 2 core wire.
- The total stated length of communication wiring is determined by the interconnecting length of indoor to outdoor wire plus the length of the central control communication wire.

▼ Communication line

Control wiring between indoor units, and outdoor unit (2-core shield wire)	Wire size	(Up to 1000m) 1.25 mm ² (Up to 2000m) 2.0 mm ²
Central control line wiring (2-core shield wire)	Wire size	(Up to 1000m) 1.25 mm ² (Up to 2000m) 2.0 mm ²

Wired remote controller wiring

This wiring is not required when using the supplied wireless remote controller.

- For wiring remote controllers a 2 core non polarity wire must be used.

Wired remote controller wiring, remote controller inter-unit wiring	Wire size: 0.5mm ² to 2.0mm ²	
Total wire length of wired remote controller wiring and remote controller inter-unit wiring = L + L1 + L2 + ... Ln	In case of wired type only	Up to 500m
	In case of wireless type included	Up to 400m
Total wire length of wired remote controller inter-unit wiring = L1 + L2 + ... Ln	Up to 200m	

CAUTION

The remote controller wire (Communication line) and AC220–240V wires cannot be parallel to contact each other and cannot be stored in the same conduits. If doing so, a trouble may be caused on the control system due to noise, etc.

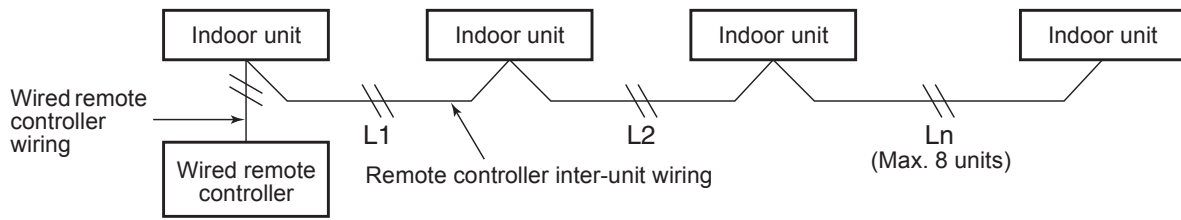

■ Control wiring between indoor and outdoor units

NOTE

An outdoor unit that is interconnected to the indoor units automatically becomes the header unit.

▼ Wiring example

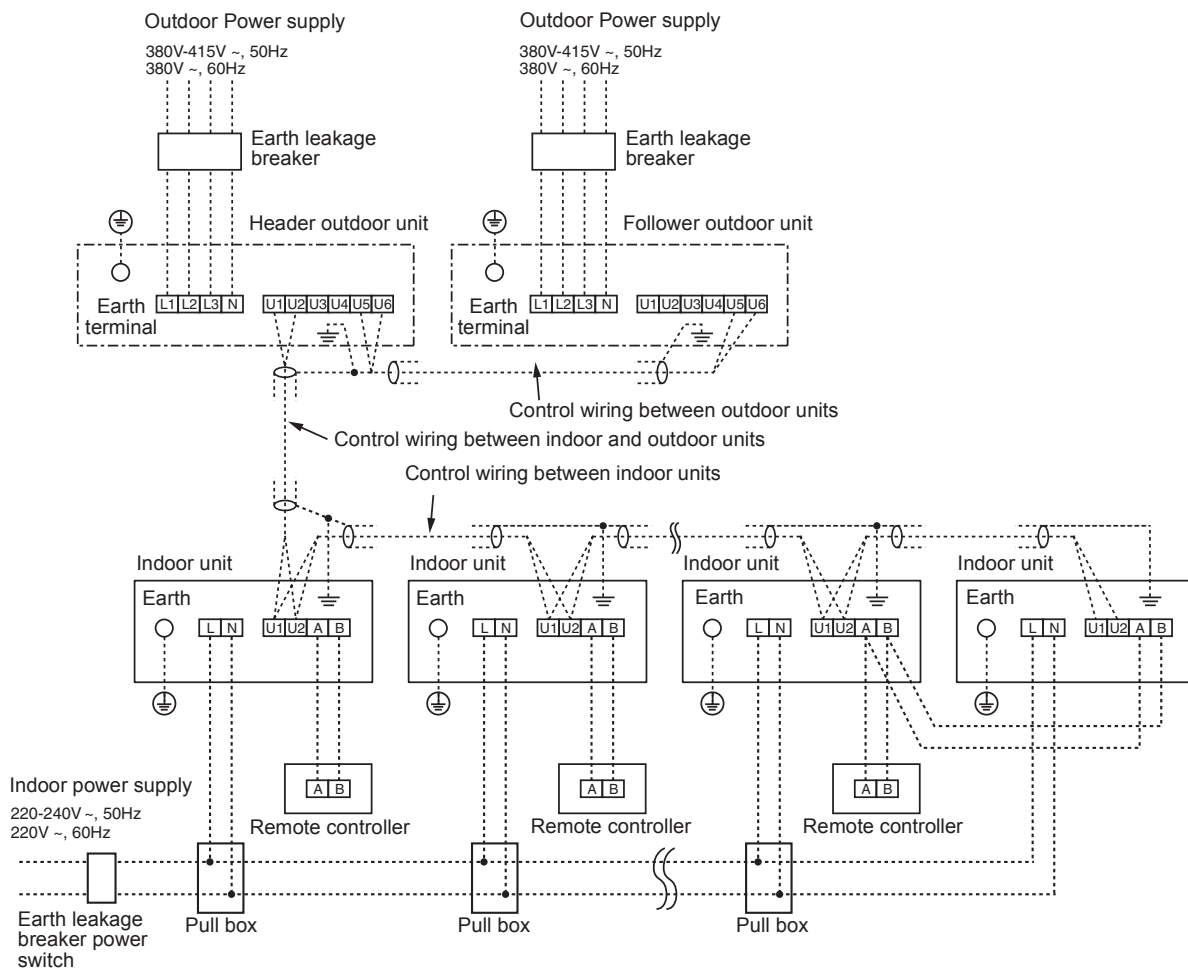

■ Address setup

Set up the addresses as per the Installation Manual supplied with the outdoor unit.

■ Wired remote controller wiring

- As the wired remote controller wire has non-polarity, there is no problem if connections to indoor unit terminal blocks A and B are reversed.

▼ Wiring diagram

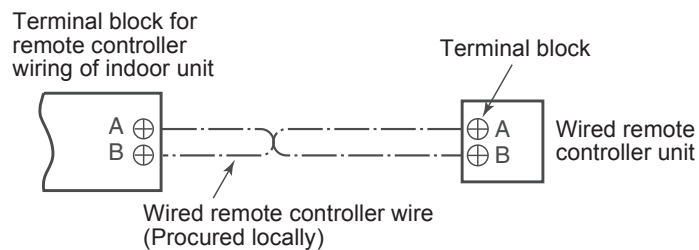

■ Wiring Connection

How to connect the power supply wiring and control wiring

The power supply wire and the control wire can be connected without removing the front panel.

REQUIREMENT

Connect the power supply wire after connecting the control wire for this model.

1. Remove the air inlet grille.
Open the air inlet grille upward and pull it toward you.
2. Remove the terminal cover and the clamp base.
3. Insert the power supply wire and control wire (according to the local rule) into the pipe hole on the wall.
4. Take the power supply wire out of the cable slot on the rear panel so that it protrudes about 150mm from the front.
5. Insert the control wire fully into the control/wired remote controller terminal block (U₁, U₂, A, B) and secure it tightly with screws.
6. Clamp the control wire with the cord clamp.
7. Install the clamp base with a screw.
8. Insert the power supply wire fully into the terminal block and secure it tightly with screws. Tightening torque: 1.2 N·m (0.12 kgf·m) Secure the earth line with the earth screw.
9. Clamp the power supply wire with the cord clamp.
10. Attach the terminal cover and the air inlet grille to the indoor unit.

CAUTION

- Be sure to refer to the wiring diagram attached inside the front panel.
- Check local electrical cords and also any specific wiring instructions and limitations.
- Do not catch the control wire when installing the clamp base.

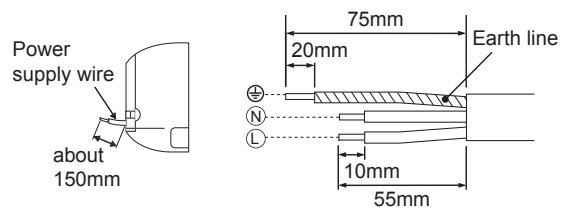
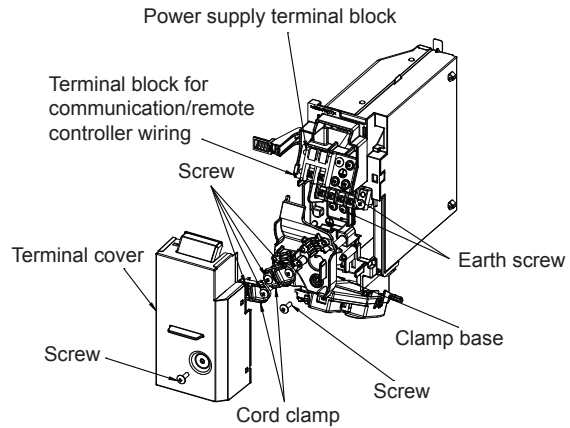

<Stripping length of the power supply wire>

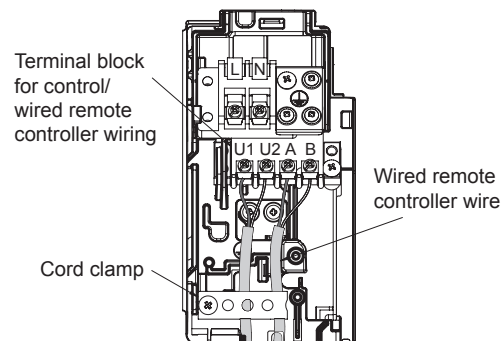
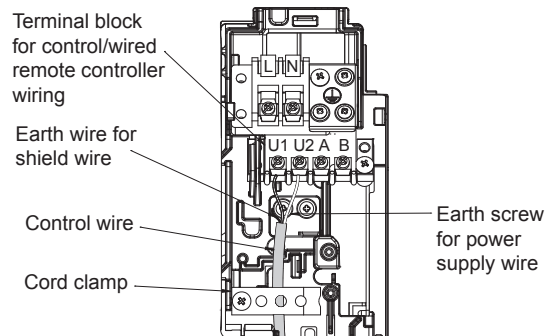

<Connecting wired remote controller wire>

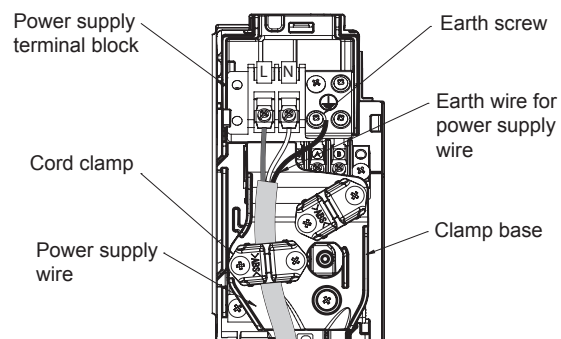

■ Wiring connection for flow selector unit

How to connect the wiring of flow selector unit

Connect the power supply wire and the communication wire supplied with the flow selector unit to the indoor unit.

1. Remove the air inlet grille.
Open the air inlet grille upward and pull it toward you.
2. Remove the terminal cover and the clamp base.
3. Insert the control wire fully into the control/wired remote controller terminal block and secure it tightly with screws.
4. Connect the control wire connector of the flow selector unit to the lead with a connector to the left of the control/wired remote controller terminal block.
5. Clamp the control wire and the control wire of the flow selector unit with the cord clamp.
6. Install the clamp base with a screw.
7. Insert the power supply wire fully into the terminal block and secure it tightly with screws.
Tightening torque: 1.2 N·m (0.12 kgf·m)
Secure the earth line with the earth screw.
8. Clamp the power supply wire with the cord clamp.
9. Insert the power supply wire fasten terminal of the flow selector unit into the power supply terminal.
10. Secure the earth line with the earth screw.
11. Clamp the power supply wire of the flow selector unit tight with the cord clamp.
12. Attach the terminal cover, the front panel and the air inlet grille to the indoor unit.

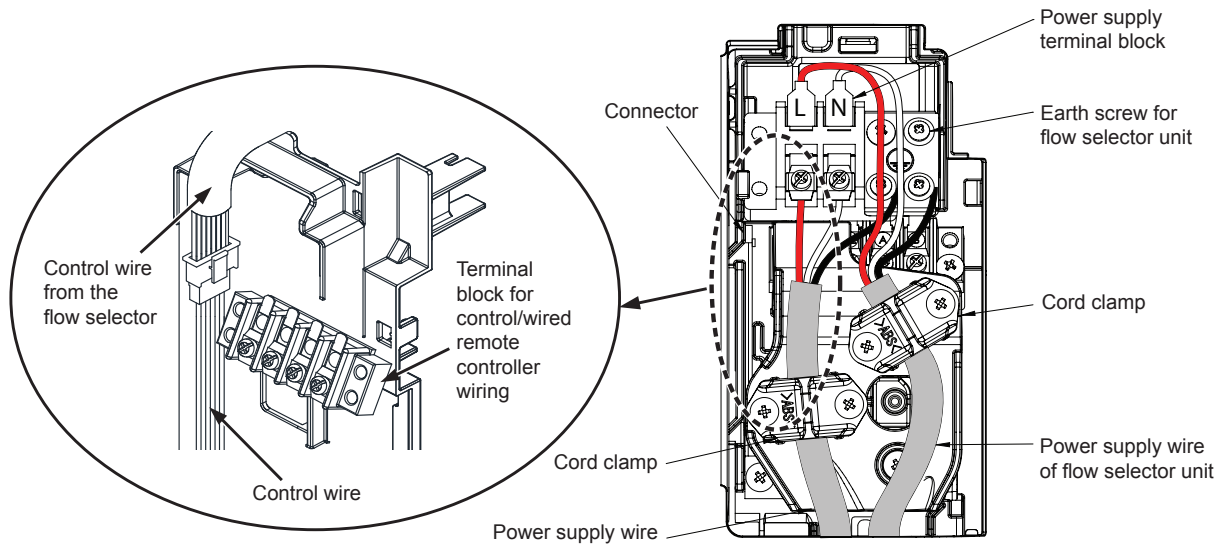

⚠ CAUTION

Confirm that every wires are stored in the electric parts box without getting caught before attaching the terminal cover.

11 APPLICABLE CONTROLS

A wired remote controller is necessary for this function. This function cannot be operate with a wireless remote controller.

REQUIREMENT

- When you use this air conditioner for the first time, it takes approx. 5 minutes until the remote controller becomes available after power-on. This is normal.

<When power is turned on for the first time after installation>

It takes **approx. 5 minutes** until the remote controller becomes available.

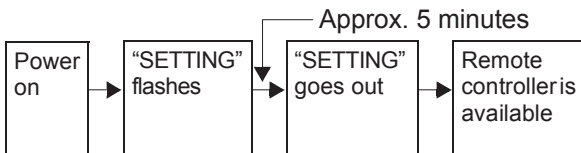

<When power is turned on for the second (or later) time>

It takes **approx. 1 minute** until the remote controller becomes available.

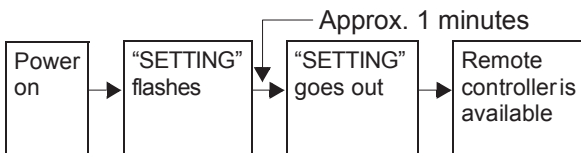

- Normal settings were made when the indoor unit was shipped from factory. Change the indoor unit settings as required.
- Use the wired remote controller to change the settings.
 - * The settings cannot be changed using the wireless remote controller, sub remote controller, or remote-controller less system (for central remote controller only). Therefore, install the wired remote controller to change the settings.

Changing of settings of for applicable controls

Basic procedure for changing settings

Change the settings while the air conditioner is not working.

(Be sure to stop the air conditioner before making settings.)

The display content for setting differs from that on the former types of remote controller (RBC-AMT21E/AMT31E). (The number of CODE No. has increased.)

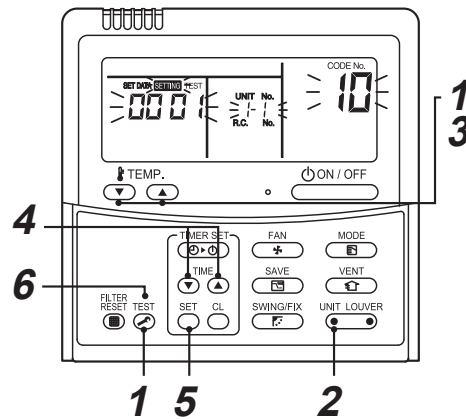

Procedure 1

Push **TEST** button and "TEMP." button simultaneously for at least 4 seconds.

After a while, the display flashes as shown in the figure.

Confirm that the CODE No. is [10].

- If the CODE No. is not [10], push **TEST** button to erase the display content, and repeat the procedure from the beginning. (No operation of the remote controller is accepted for a while after **TEST** button is pushed.) (While air conditioners are operated under the group control, "ALL" is displayed first. When **UNIT LOUVER** is pushed, the indoor unit number displayed following "ALL" is the header unit.)

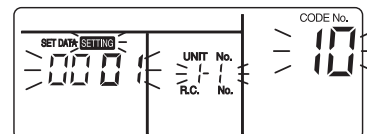

(* Display content varies with the indoor unit model.)

Procedure 2

Each time you push  button, indoor unit numbers in the control group change cyclically. Select the indoor unit you want to change settings for.

The fan of the selected unit runs and the louvers start swinging. You can confirm the indoor unit for which you want to change settings.

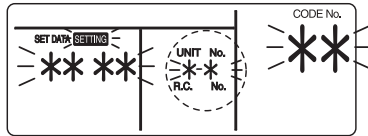

Procedure 3



Using “TEMP.”  /  buttons, specify CODE No.. [**].

Procedure 4

Using timer “TIME”  /  buttons, select SET DATA [****].

Procedure 5

Push  button. When the display changes from flashing to lit, the setup is completed.

- To change settings of another indoor unit, repeat from Procedure 2.
- To change other settings of the selected indoor unit, repeat from Procedure 3.
Use  button to clear the settings.
To make settings after  button was pushed, repeat from Procedure 2.

Procedure 6

When settings have been completed, push  button to determine the settings.

When  button is pushed, “SETTING” flashes and then the display content disappears and the air conditioner enters the normal stop mode.

(While “SETTING” is flashing, no operation of the remote controller is accepted.)

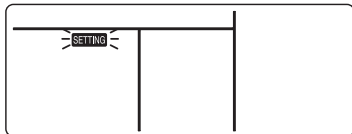

Change of lighting time of filter sign

According to the installation condition, the lighting time of the filter sign (Notification of filter cleaning) can be changed.

Follow to the basic operation procedure

(1 → 2 → 3 → 4 → 5 → 6).

- For the CODE No.. in Procedure 3, specify [01].
- For the [SET DATA] in Procedure 4, select the SET DATA of filter sign lighting time from the following table.

SET DATA	Filter sign lighting time
0000	None
0001	150H (Factory setting)
0002	2500H
0003	5000H
0004	10000H

To secure better effect of heating

When it is difficult to obtain satisfactory heating due to installation place of the indoor unit or structure of the room, the detection temperature of heating can be raised. Also use a circulator, etc. to circulate heat air near the ceiling.

Follow to the basic operation procedure

(1 → 2 → 3 → 4 → 5 → 6).

- For the CODE No.. in Procedure 3, specify [06].
- For the SET DATA in Procedure 4, select the SET DATA of shift value of detection temperature to be set up from the table below.

SET DATA	Detection temp shift value
0000	No shift
0001	+1°C
0002	+2°C (Factory setting)
0003	+3°C
0004	+4°C
0005	+5°C
0006	+6°C

■ Adjustment of air direction

1. Using the remote controller switch, change the up/down air direction by moving the horizontal louver.
2. Adjust the right/left air direction by bending the vertical grille inside of the air outlet port with hands.

REQUIREMENT

Do not touch the horizontal louver directly with hands; otherwise a trouble may be caused. For handling of the horizontal louver, refer to "Owner's Manual" attached to the outdoor unit.

■ Group control

In a group control, a remote controller can control up to maximum 8 units.

- The wired remote controller only can control a group control. The wireless remote controller is unavailable for this control.
- For cabling procedure and cables of the individual line (Identical refrigerant line) system, refer to "Electric work" in this Manual.
- Cabling between indoor units in a group is performed in the following procedure. Connect the indoor units by connecting the remote controller inter-unit cables from the remote controller terminal blocks (A, B) of the indoor unit connected with a remote controller to the remote controller terminal blocks (A, B) of the other indoor unit. (Non-polarity)
- For address setup, refer to the Installation Manual attached to the outdoor unit.

NOTE

Net work adapter (Model TCB-PCNT20E) can not connect to this High Wall type air conditioner.

12 TEST RUN

A wired remote controller is necessary for this function. This function cannot be operate with a wireless remote controller.

■ Before test run

- Before turning on the power supply, carry out the following procedure.
 - 1) Using 500V-megger, check that resistance of 1MΩ or more exists between the terminal block of the power supply and the earth (grounding).
If resistance of less than 1MΩ is detected, do not run the unit.
 - 2) Check the valve of the outdoor unit being opened fully.
- To protect the compressor at activation time, leave power-ON for 12 hours or more before operating.

⚠ WARNING

- Never press the electromagnetic contactor to forcibly perform a test run. (This is very dangerous because the protective device does not work.)
- Before starting a test run, be sure to set addresses following the installation manual supplied with the outdoor unit.

■ How to execute a test run

Using the wired remote controller, operate the unit as usual.

For the procedure of the operation, refer to the attached Owner's Manual.

A forced test run can be executed in the following procedure even if the operation stops by thermo.-OFF.

In order to prevent a serial operation, the forced test run is released after 60 minutes have passed and returns to the usual operation.

⚠ CAUTION

- Do not use the forced test run for cases other than the test run because it applies an excessive load to the devices.

In case of wired remote controller

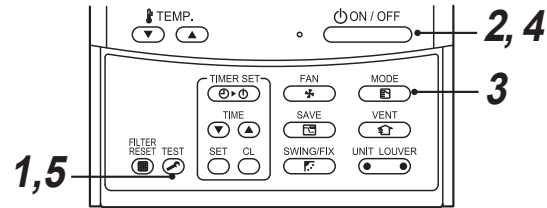

Procedure 1

Keep **TEST** button pushed for 4 seconds or more. [TEST] is displayed on the display part and the selection of mode in the test mode is permitted.

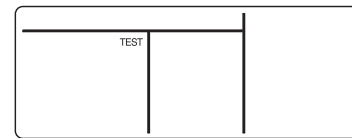

Procedure 2

Push **ON/OFF** button.

Procedure 3

Using **MODE** button, select the operation mode, [COOL] or [HEAT].

- Do not run the air conditioner in a mode other than [COOL] or [HEAT].
- The temperature controlling function does not work during test run.
- The detection of error is performed as usual.

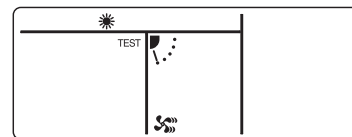

Procedure 4

After the test run, push **ON/OFF** button to stop a test run.

(Display part is same as procedure 1.)

Procedure 5

Push **TEST** check button to cancel (release from) the test run mode.

([TEST] disappears on the display and the status returns to a normal.)

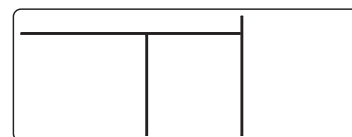

In case of wireless remote controller
(Forced test operation is performed in a
different way.)

REQUIREMENT

- For the operation procedure, be sure to follow the Owner's Manual.
- Finish the forced cooling operation in a short time because it applies excessive strength to the air conditioner.
- A test operation of forced heating is unavailable. Perform a test operation by heating operation using the switches of the remote controller.
However heating operation may be not carried out according to the temperature conditions.

- **Check wiring/piping of indoor and outdoor units**
 1. When pushing [RESET] button for 10 seconds or more, "Pi!" sound is heard and the operation changes to a forced cooling operation. After approx. 3 minutes, a cooling operation starts forcedly. Check cool air starts blowing. If the operation does not start, check wiring again.
 2. To stop a test operation, push [RESET] button once again (Approx. 1 second). The louver closes and the operation stops.

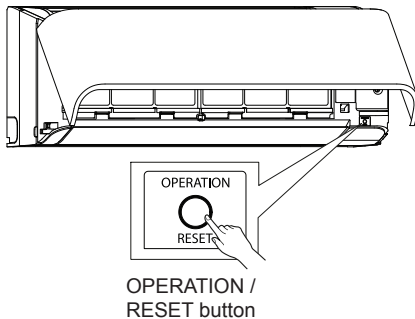

- **Check transmission of remote controller**
 1. Push "START/STOP" button of the remote controller to check an operation can also start by the remote controller.
 - "Cooling" operation by the remote controller may be unavailable according to the temperature conditions.
Check wiring/piping of the indoor and outdoor units in forced cooling operation.

13 TROUBLESHOOTING

A wired remote controller is necessary for this function. This function cannot be operate with a wireless remote controller.

Confirmation and check

When a trouble occurred in the air conditioner, the check code and the indoor UNIT No. appear on the display part of the remote controller.

The check code is only displayed during the operation.

If the display disappears, operate the air conditioner according to the following "Confirmation of error history" for confirmation.

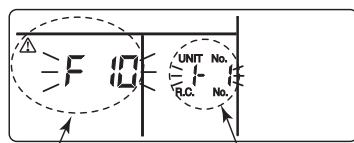

Check code

Indoor UNIT No. in which an error occurred

Confirmation of error history

When a trouble occurred on the air conditioner, the trouble history can be confirmed with the following procedure. (The trouble history is stored in memory up to 4 troubles.)

The history can be confirmed from both operating status and stop status.

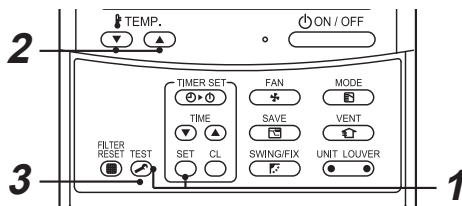

Procedure 1



When pushing **SET** and **TEST** buttons at the same time for 4 seconds or more, the following display appears.

If [Service check]  is displayed, the mode enters in the trouble history mode.

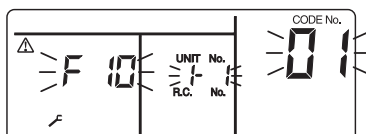
- [01: Order of trouble history] is displayed in CODE No. window.
- [Check code] is displayed in CHECK window.
- [Indoor unit address in which an error occurred] is displayed in UNIT No.



Procedure 2

Every pushing of "TEMP."   button used to set temperature, the trouble history stored in memory is displayed in order.

The numbers in CODE No. indicate CODE No. [01] (latest) → [04] (oldest).

REQUIREMENT

Do not push **CL** button because all the trouble history of the indoor unit will be deleted.

Procedure 3

After confirmation, push **TEST**  button to return to the usual display.

■ Check method

On the remote controller (Wired remote controller, Central control remote controller) and the interface P.C. board of the outdoor unit (I/F), a check display LCD (Remote controller) or 7-segment display (on the outdoor interface P.C. board) to display the operation is provided. Therefore the operation status can be known. Using this self-diagnosis function, a trouble or position with error of the air conditioner can be found as shown in the table below.

■ Check code list

The following list shows each check code. Find the check contents from the list according to part to be checked.

- In case of check from indoor remote controller: See “Wired remote controller display” in the list.
- In case of check from outdoor unit: See “Outdoor 7-segment display” in the list.
- In case of check from indoor unit with wireless remote controller: See “Sensor block display of receiving unit” in the list.

AI-NET: Artificial Intelligence.

IPDU: Intelligent Power Drive Unit

○: Lighting, ◻: Flashing, ●: Goes off

ALT.: Flashing is alternately when there are two flashing LED.

SIM: Simultaneous flashing when there are two flashing LED.

Check code			Wireless remote controller				Check code name	Judging device
Wired remote controller display	Outdoor 7-segment display		Sensor block display of receiving unit					
		Auxiliary code	OPERATION	TIMER	PRE.DEF.	Flash		
E01	—	—	◻	●	●		Communication error between indoor and remote controller (Detected at remote controller side)	Remote controller
E02	—	—	◻	●	●		Remote controller transmission error	Remote controller
E03	—	—	◻	●	●		Communication error between indoor and remote controller (Detected at indoor side)	Indoor
E04	—	—	●	●	◻		Communication circuit error between indoor/outdoor (Detected at indoor side)	Indoor
E06	E06	No. of indoor units in which sensor has been normally received	●	●	◻		Decrease of No. of indoor units	I/F
—	E07	—	●	●	◻		Communication circuit error between indoor/outdoor (Detected at outdoor side)	I/F
E08	E08	Duplicated indoor addresses	◻	●	●		Duplicated indoor addresses	Indoor / I/F
E09	—	—	◻	●	●		Duplicated main remote controllers	Remote controller
E10	—	—	◻	●	●		Communication error between indoor MCU	Indoor
E12	E12	01: Indoor/Outdoor communication 02: Communication between outdoor units	◻	●	●		Automatic address start error	I/F
E15	E15	—	●	●	◻		Indoor is nothing during automatic addressing	I/F
E16	E16	00: Capacity over 01 ~:No. of connected units	●	●	◻		Capacity over / No. of connected indoor units	I/F
E18	—	—	◻	●	●		Communication error between indoor units	Indoor
E19	E19	00: Header is nothing 02: Two or more header units	●	●	◻		Outdoor header units quantity error	I/F
E20	E20	01: Outdoor of other line connected 02: Indoor of other line connected	●	●	◻		Other line connected during automatic address	I/F

E23	E23	—	● ● □		Sending error in communication between outdoor units	I/F
E25	E25	—	● ● □		Duplicated follower outdoor addresses	I/F
E26	E26	No. of outdoor units which received signal normally	● ● □		Decrease of No. of connected outdoor units	I/F
E28	E28	Detected outdoor unit number	● ● □		Follower outdoor unit error	I/F
E31	E31	01: IPDU1 error 02: IPDU2 error 03: IPDU1, 2 error 04: Fan IPDU error 05: IPDU + Fan IPDU error 06: IPDU2 + Fan IPDU error 07: All IPDU error	● ● □		IPDU communication error	I/F
F01	—	—	□ □ ●	ALT	Indoor TCJ sensor error	Indoor
F02	—	—	□ □ ●	ALT	Indoor TC2 sensor error	Indoor
F03	—	—	□ □ ●	ALT	Indoor TC1 sensor error	Indoor
F04	F04	—	□ □ ○	ALT	TD1 sensor error	I/F
F05	F05	—	□ □ ○	ALT	TD2 sensor error	I/F
F06	F06	—	□ □ ○	ALT	TE1 sensor error	I/F
F07	F07	—	□ □ ○	ALT	TL sensor error	I/F
F08	F08	—	□ □ ○	ALT	TO sensor error	I/F
F10	—	—	□ □ ●	ALT	Indoor TA sensor error	Indoor
F12	F12	—	□ □ ○	ALT	TS1 sensor error	I/F
F13	F13	01: Comp. 1 side 02: Comp. 2 side	□ □ ○	ALT	TH sensor error	IPDU
F15	F15	—	□ □ ○	ALT	Outdoor temp. sensor miscabling (TE, TL)	I/F
F16	F16	—	□ □ ○	ALT	Outdoor pressure sensor miscabling (Pd, Ps)	I/F
F23	F23	—	□ □ ○	ALT	Ps sensor error	I/F
F24	F24	—	□ □ ○	ALT	Pd sensor error	I/F
F29	—	—	□ □ ●	SIM	Indoor other error	Indoor
F31	F31	—	□ □ ○	SIM	Indoor EEPROM error	I/F
H01	H01	01: Comp. 1 side 02: Comp. 2 side	● □ ●		Compressor break down	IPDU
H02	H02	01: Comp. 1 side 02: Comp. 2 side	● □ ●		Magnet switch error Overcurrent relay operation Compressor trouble (lock)	MG-SW Overcurrent relay IPDU
H03	H03	01: Comp. 1 side 02: Comp. 2 side	● □ ●		Current detect circuit system error	IPDU
H04	H04	—	● □ ●		Comp 1 case thermo operation	I/F
H06	H06	—	● □ ●		Low pressure protective operation	I/F
H07	H07	—	● □ ●		Oil level down detective protection	I/F
H08	H08	01: TK1 sensor error 02: TK2 sensor error 03: TK3 sensor error 04: TK4 sensor error	● □ ●		Oil level detective temp sensor error	I/F
H14	H14	—	● □ ●		Comp 2 case thermo operation	I/F
H16	H16	01: TK1 oil circuit system error 02: TK2 oil circuit system error 03: TK3 oil circuit system error 04: TK4 oil circuit system error	● □ ●		Oil level detective circuit error Magnet switch error Overcurrent relay operation	I/F MG-SW Overcurrent relay
L03	—	—	□ ● □	SIM	Indoor centre unit duplicated	Indoor
L04	L04	—	□ ○ □	SIM	Outdoor line address duplicated	I/F
L05	—	—	□ ● □	SIM	Duplicated indoor units with priority (Displayed in indoor unit with priority)	I/F
L06	L06	No. of indoor units with priority	□ ● □	SIM	Duplicated indoor units with priority (Displayed in unit other than indoor unit with priority)	I/F
L07	—	—	□ ● □	SIM	Group line in individual indoor unit	Indoor
L08	L08	—	□ ● □	SIM	Indoor group/Address unset	Indoor, I/F

L09	—	—	☐ ● ☐	SIM	Indoor capacity unset	Indoor
L10	L10	—	☐ ○ ☐	SIM	Outdoor capacity unset	I/F
L20	—	—	☐ ○ ☐	SIM	Duplicated central control addresses	AI-NET, Indoor
L28	L28	—	☐ ○ ☐	SIM	Over No. of connected outdoor units	I/F
L29	L29	01: IPDU1 error 02: IPDU2 error 03: IPDU3 error 04: Fan IPDU error 05: IPDU1 + Fan IPDU error 06: IPDU2 + Fan IPDU error 07: All IPDU error	☐ ○ ☐	SIM	No. of IPDU error	I/F
L30	L30	Detected indoor address	☐ ○ ☐	SIM	Indoor outside interlock	Indoor
—	L31	—	—		Extended I/C error	I/F
P01	—	—	● ☐ ☐	ALT	Indoor fan motor error	Indoor
P03	P03	—	☐ ● ☐	ALT	Discharge temp. TD1 error	I/F
P04	P04	01: Comp. 1 side 02: Comp. 2 side	☐ ● ☐	ALT	High-pressure SW system operation	IPDU
P05	P05	01: Phase-missing detection 02: Phase error	☐ ● ☐	ALT	Phase-missing detection /Phase error	I/F
P07	P07	01: Comp. 1 side 02: Comp. 2 side	☐ ● ☐	ALT	Heat sink overheat error	IPDU, I/F
P10	P10	Detected indoor address	● ☐ ☐	ALT	Indoor overflow error	Indoor
P12	—	—	● ☐ ☐	ALT	Indoor fan motor error	Indoor
P13	P13	—	● ☐ ☐	ALT	Outdoor liquid back detection error	I/F
P15	P15	01: TS condition 02: TD condition	☐ ● ☐	ALT	Gas leak detection	I/F
P17	P17	—	☐ ● ☐	ALT	Discharge temp. TD2 error	I/F
P19	P19	Detected outdoor unit number	☐ ● ☐	ALT	4-way valve inverse error	I/F
P20	P20	—	☐ ● ☐	ALT	High-pressure protective operation	I/F
P22	P22	0_ : IGBT short 1_ : Fan motor position detective circuit error 3_ : Fan motor trouble C_ : TH sensor temp. error (Heat sink overheat) D_ : TH sensor error E_ : Vdc output error	☐ ● ☐	ALT	Outdoor fan IPDU error	IPDU
P26	P26	01: Comp. 1 side 02: Comp. 2 side	☐ ● ☐	ALT	G-TR short protection error	IPDU
P29	P29	01: Comp. 1 side 02: Comp. 2 side	☐ ● ☐	ALT	Comp position detective circuit system error	IPDU
P31	P31	—	☐ ● ☐	ALT	Other indoor unit error (Group terminal unit error)	Indoor
—	—	—	By alarm device ALT		Error in indoor group	AI-NET

Error detected by TCC-LINK central control device

Check code		Wireless remote controller		Check code name	Judging device	
Central control device indication	Outdoor 7-segment display	Sensor block display of receiving unit				
	Auxiliary code	OPERATION	TIMER PRE.DEF.	Flash		
C05	—	—	—	Sending error in TCC-LINK central control device	TCC-LINK	
C06	—	—	—	Receiving error in TCC-LINK central control device	TCC-LINK	
C12	—	—	—	Batch alarm of general-purpose equipment control interface	General-purpose equipment I/F	
P30	Differs according to error contents of unit with occurrence of alarm				Group control branching unit error	TCC-LINK
	—	—	(L20 is displayed.)		Duplicated central control addresses	

TCC-LINK: TOSHIBA Carrier Communication Link.

WARNINGS ON REFRIGERANT LEAKAGE

Check of Concentration Limit

The room in which the air conditioner is to be installed requires a design that in the event of refrigerant gas leaking out, its concentration will not exceed a set limit.

The refrigerant R410A which is used in the air conditioner is safe, without the toxicity or combustibility of ammonia, and is not restricted by laws to be imposed which protect the ozone layer. However, since it contains more than air, it poses the risk of suffocation if its concentration should rise excessively. Suffocation from leakage of R410A is almost non-existent. With the recent increase in the number of high concentration buildings, however, the installation of multi air conditioner systems is on the increase because of the need for effective use of floor space, individual control, energy conservation by curtailing heat and carrying power etc. Most importantly, the multi air conditioner system is able to replenish a large amount of refrigerant compared with conventional individual air conditioners. If a single unit of the multi conditioner system is to be installed in a small room, select a suitable model and installation procedure so that if the refrigerant accidentally leaks out, its concentration does not reach the limit (and in the event of an emergency, measures can be made before injury can occur).

In a room where the concentration may exceed the limit, create an opening with adjacent rooms, or install mechanical ventilation combined with a gas leak detection device.

The concentration is as given below.

$$\frac{\text{Total amount of refrigerant (kg)}}{\text{Min. volume of the indoor unit installed room (m}^3\text{)}} \leq \text{Concentration limit (kg/m}^3\text{)}$$

The concentration limit of R410A which is used in multi air conditioners is 0.3kg/m³.

▼ NOTE 1

If there are 2 or more refrigerating systems in a single refrigerating device, the amounts of refrigerant should be as charged in each independent device.

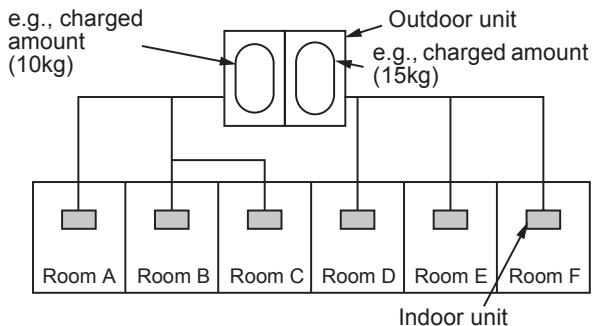

For the amount of charge in this example:

The possible amount of leaked refrigerant gas in rooms A, B and C is 10kg.

The possible amount of leaked refrigerant gas in rooms D, E and F is 15kg.

▼ NOTE 2

The standards for minimum room volume are as follows.

- (1) No partition (shaded portion)

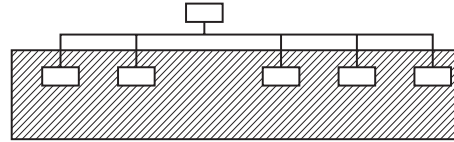

- (2) When there is an effective opening with the adjacent room for ventilation of leaking refrigerant gas (opening without a door, or an opening 0.15% or larger than the respective floor spaces at the top or bottom of the door).

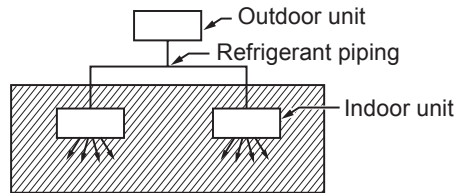

- (3) If an indoor unit is installed in each partitioned room and the refrigerant piping is interconnected, the smallest room of course becomes the object. But when a mechanical ventilation is installed interlocked with a gas leakage detector in the smallest room where the density limit is exceeded, the volume of the next smallest room becomes the object.

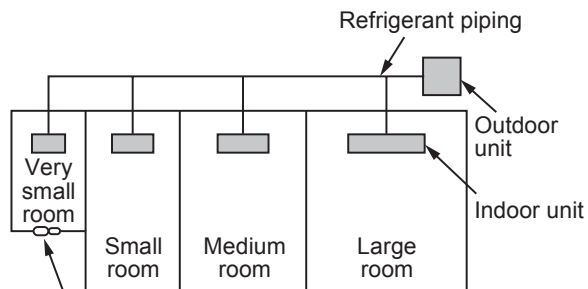

Mechanical ventilation device - Gas leak detector

▼ NOTE 3

The minimum indoor floor area compared with the amount of refrigerant is roughly as follows: (When the ceiling is 2.7m high)

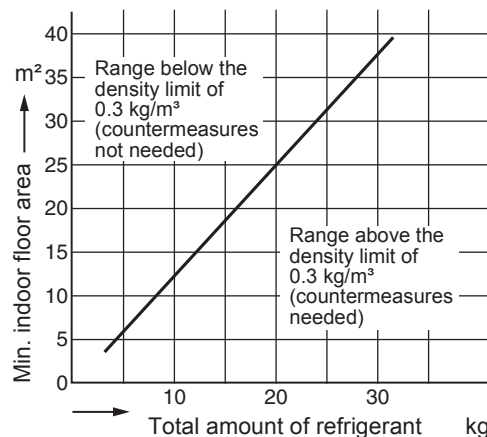

CONFIRMATION OF INDOOR UNIT SETUP

Prior to delivery to the customer, check the address and setup of the indoor unit, which has been installed in this time and fill the check sheet (Table below). Data of four units can be entered in this check sheet. Copy this sheet according to the No. of the indoor units. If the installed system is a group control system, use this sheet by entering each line system into each installation manual attached to the other indoor units.

REQUIREMENT

This check sheet is required for maintenance after installation. Be sure to fill this sheet and then pass this Installation Manual to the customers.

Indoor unit setup check sheet

Indoor unit			Indoor unit			Indoor unit			Indoor unit		
Room name			Room name			Room name			Room name		
Model			Model			Model			Model		
Check indoor unit address. (For check method, refer to Applicable controls in this sheet.)											
* In case of a single system, it is unnecessary to enter the indoor address. (CODE No.: Line [12], Indoor [13], Group [14], Central control [03])											
Line	Indoor	Group	Line	Indoor	Group	Line	Indoor	Group	Line	Indoor	Group
Central control address			Central control address			Central control address			Central control address		
Various setup			Various setup			Various setup			Various setup		
Have you changed high ceiling setup? If not, fill check mark [x] in [NO CHANGE], and fill check mark [x] in [ITEM] if changed, respectively. (For check method, refer to Applicable controls in this sheet.) * In case of replacement of short plugs on indoor microcomputer P.C. board, setup is automatically changed.											
High ceiling setup (CODE No. [5d])			High ceiling setup (CODE No. [5d])			High ceiling setup (CODE No. [5d])			High ceiling setup (CODE No. [5d])		
<input type="checkbox"/> NO CHANGE			<input type="checkbox"/> NO CHANGE			<input type="checkbox"/> NO CHANGE			<input type="checkbox"/> NO CHANGE		
<input type="checkbox"/> STANDARD [0000]			<input type="checkbox"/> STANDARD [0000]			<input type="checkbox"/> STANDARD [0000]			<input type="checkbox"/> STANDARD [0000]		
<input type="checkbox"/> HIGH CEILING 1 [0001]			<input type="checkbox"/> HIGH CEILING 1 [0001]			<input type="checkbox"/> HIGH CEILING 1 [0001]			<input type="checkbox"/> HIGH CEILING 1 [0001]		
<input type="checkbox"/> HIGH CEILING 3 [0003]			<input type="checkbox"/> HIGH CEILING 3 [0003]			<input type="checkbox"/> HIGH CEILING 3 [0003]			<input type="checkbox"/> HIGH CEILING 3 [0003]		
Have you changed lighting time of filter sign? If not, fill check mark [x] in [NO CHANGE], and fill check mark [x] in [ITEM] if changed, respectively. (For check method, refer to Applicable controls in this sheet.)											
Filter sign lighting time (CODE No. [01])			Filter sign lighting time (CODE No. [01])			Filter sign lighting time (CODE No. [01])			Filter sign lighting time (CODE No. [01])		
<input type="checkbox"/> NO CHANGE			<input type="checkbox"/> NO CHANGE			<input type="checkbox"/> NO CHANGE			<input type="checkbox"/> NO CHANGE		
<input type="checkbox"/> NONE [0000]			<input type="checkbox"/> NONE [0000]			<input type="checkbox"/> NONE [0000]			<input type="checkbox"/> NONE [0000]		
<input type="checkbox"/> 150H [0001]			<input type="checkbox"/> 150H [0001]			<input type="checkbox"/> 150H [0001]			<input type="checkbox"/> 150H [0001]		
<input type="checkbox"/> 2500H [0002]			<input type="checkbox"/> 2500H [0002]			<input type="checkbox"/> 2500H [0002]			<input type="checkbox"/> 2500H [0002]		
<input type="checkbox"/> 5000H [0003]			<input type="checkbox"/> 5000H [0003]			<input type="checkbox"/> 5000H [0003]			<input type="checkbox"/> 5000H [0003]		
<input type="checkbox"/> 10000H [0004]			<input type="checkbox"/> 10000H [0004]			<input type="checkbox"/> 10000H [0004]			<input type="checkbox"/> 10000H [0004]		
Have you changed detected temp. shift value? If not, fill check mark [x] in [NO CHANGE], and fill check mark [x] in [ITEM] if changed, respectively. (For check method, refer to Applicable control in this sheet.)											
Detected temp. shift value setup (CODE No. [06])			Detected temp. shift value setup (CODE No. [06])			Detected temp. shift value setup (CODE No. [06])			Detected temp. shift value setup (CODE No. [06])		
<input type="checkbox"/> NO CHANGE			<input type="checkbox"/> NO CHANGE			<input type="checkbox"/> NO CHANGE			<input type="checkbox"/> NO CHANGE		
<input type="checkbox"/> NO SHIFT [0000]			<input type="checkbox"/> NO SHIFT [0000]			<input type="checkbox"/> NO SHIFT [0000]			<input type="checkbox"/> NO SHIFT [0000]		
<input type="checkbox"/> +1°C [0001]			<input type="checkbox"/> +1°C [0001]			<input type="checkbox"/> +1°C [0001]			<input type="checkbox"/> +1°C [0001]		
<input type="checkbox"/> +2°C [0002]			<input type="checkbox"/> +2°C [0002]			<input type="checkbox"/> +2°C [0002]			<input type="checkbox"/> +2°C [0002]		
<input type="checkbox"/> +3°C [0003]			<input type="checkbox"/> +3°C [0003]			<input type="checkbox"/> +3°C [0003]			<input type="checkbox"/> +3°C [0003]		
<input type="checkbox"/> +4°C [0004]			<input type="checkbox"/> +4°C [0004]			<input type="checkbox"/> +4°C [0004]			<input type="checkbox"/> +4°C [0004]		
<input type="checkbox"/> +5°C [0005]			<input type="checkbox"/> +5°C [0005]			<input type="checkbox"/> +5°C [0005]			<input type="checkbox"/> +5°C [0005]		
<input type="checkbox"/> +6°C [0006]			<input type="checkbox"/> +6°C [0006]			<input type="checkbox"/> +6°C [0006]			<input type="checkbox"/> +6°C [0006]		
Incorporation of parts sold separately			Incorporation of parts sold separately			Incorporation of parts sold separately			Incorporation of parts sold separately		
Have you incorporated the following parts sold separately? If incorporated, fill check mark [x] in each [ITEM]. (When incorporating, the setup change is necessary in some cases. For setup change method, refer to Installation Manual attached to each part sold separately.)											
Panel			Panel			Panel			Panel		
<input type="checkbox"/> Standard panel			<input type="checkbox"/> Standard panel			<input type="checkbox"/> Standard panel			<input type="checkbox"/> Standard panel		
Filter			Filter			Filter			Filter		
<input type="checkbox"/> Super long life filter			<input type="checkbox"/> Super long life filter			<input type="checkbox"/> Super long life filter			<input type="checkbox"/> Super long life filter		
<input type="checkbox"/> Others ()			<input type="checkbox"/> Others ()			<input type="checkbox"/> Others ()			<input type="checkbox"/> Others ()		
<input type="checkbox"/> Others ()			<input type="checkbox"/> Others ()			<input type="checkbox"/> Others ()			<input type="checkbox"/> Others ()		

TOSHIBA CARRIER (THAILAND) CO.,LTD.

144 / 9 Moo 5, Bangkadi Industrial Park, Tivanon Road, Tambol Bangkadi, Amphur Muang, Pathumthani 12000, Thailand



1121250199